

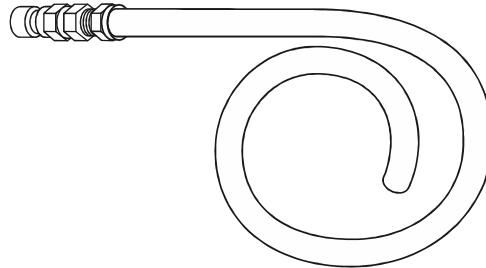

Brake Service System Completer Kit

PN PF9000C



PF9051
Suction wand

PF9051T-25
25' roll silicone tubing for PF9051



PF9049
Mini suction wand

PF9049T-25
25' roll PTFE tubing for PF9049



PF9050
Dispensing wand



PF9052
1/4" hex
bleeder adaptor



PF9053
8mm hex
bleeder adaptor



PF9054
3/8" hex
bleeder adaptor



PF9055
10mm hex
bleeder adaptor



PF9056
7/16" hex
bleeder adaptor



PF9057
7mm hex
bleeder adaptor



PF9058
9mm hex
bleeder adaptor



Brake Service System Adaptor Kit

PN PF9000

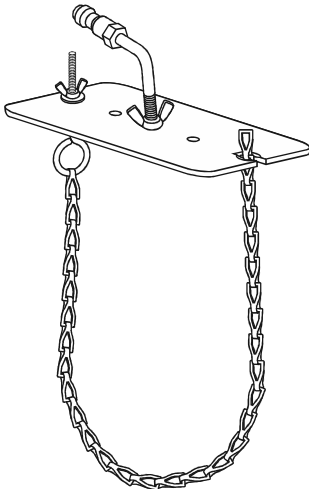

PF9001
Seal plate adaptor

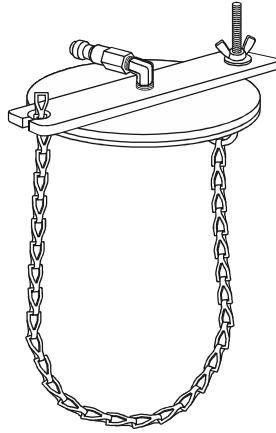

PF9002
Universal adaptor, small round

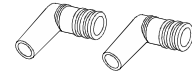

PF9023
Return hose elbow for PF7 & PF9 (2 ea.)

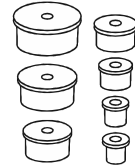

PF9007
Expanding seal universal adaptor set

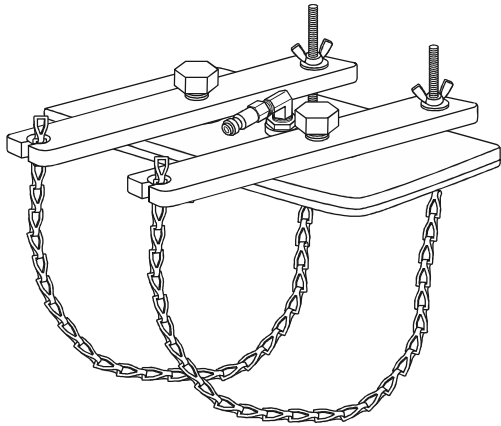

PF9003
Universal adaptor, large rectangular

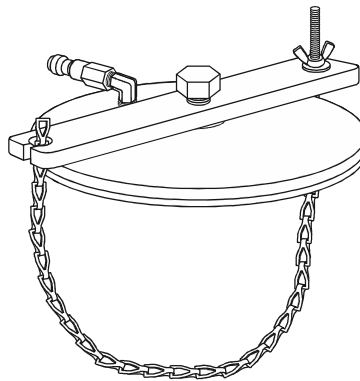

PF9004
Universal adaptor, large round

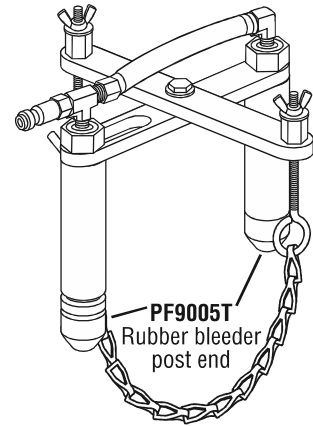

PF9005
GM bypass adaptor (Direct contact adaptor)

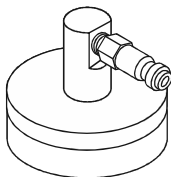

PF9008
GM brake cap adaptor

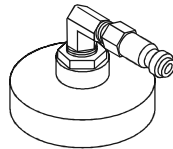

PF9009
Chrysler brake cap adaptor

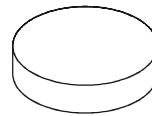

PF9010
Chrysler brake cap plug

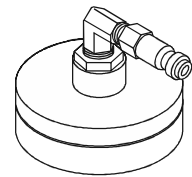

PF9011
Ford brake cap adaptor



G0003-013
EPDM O-ring #013



G0003-013
EPDM O-ring #013



G0003-013
EPDM O-ring #013

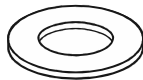

PF91002
Brake cap adaptor seal, 1.9"

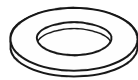

PF91001
Brake cap adaptor seal, 1.75"



PF91001
Brake cap adaptor seal, 1.75"



PF91002
Brake cap adaptor seal, 1.9"



Brake Service System Adaptor Kit

PN PF9000

(continued from previous page)

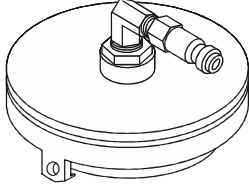

PF9012
Honda brake cap
adaptor

G0003-013
EPDM O-ring #013

G0003-225
EPDM O-ring #225

PF9-300
EPDM gasket #329 for PF9012

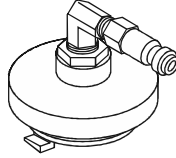

PF9013
Toyota brake cap
adaptor

G0003-013
EPDM O-ring #013

G0003-128
EPDM O-ring #128

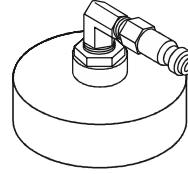

PF9014
Mazda brake cap
adaptor

G0003-013
EPDM O-ring #013

PF91001
Brake cap
adaptor seal, 1.75"

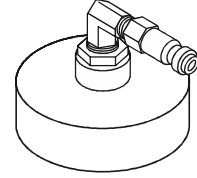

PF9015
European brake
cap adaptor

G0003-013
EPDM O-ring #013

PF91001
Brake cap
adaptor seal, 1.75"



PF7 Optional Adaptors

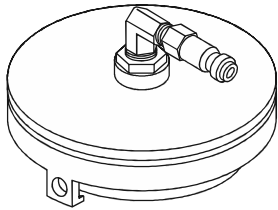

PF9016
Honda large brake cap adaptor

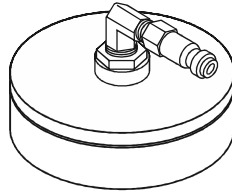

PF9017
Suzuki brake cap adaptor

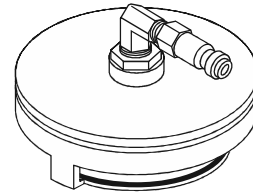

PF9020
Isuzu Trooper brake cap adaptor



G0003-013
EPDM O-ring #013



G0003-013
EPDM O-ring #013



G0003-013
EPDM O-ring #013



G0003-231
EPDM O-ring #231



G0003-138
EPDM O-ring #138



G0003-225
EPDM O-ring #225

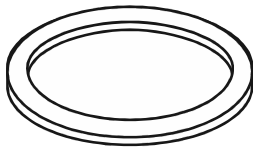

G0005-335
Square-cut O-rings EPDM #335



PF9017-3
Suzuki brake cap adaptor seal



PF9020-3
Isuzu Trooper brake cap adaptor seal

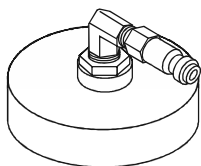

PF9021
Mitsubishi/large Volvo brake cap adaptor

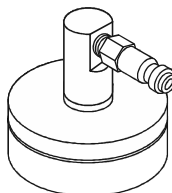

PF9018
Land Rover brake cap adaptor

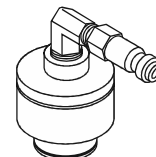

PF9019
Nissan brake cap adaptor



G0003-013
EPDM O-ring #013



G0003-013
EPDM O-ring #013



G0003-116
EPDM O-ring #116

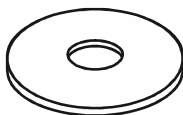

PF9021-2
Volvo large brake cap adaptor seal

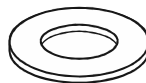

PF91002
Brake cap adaptor seal, 1.9"

(continued on next page)



PF7 Optional Adaptors

(continued from previous page)

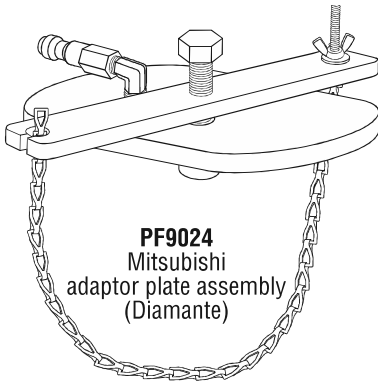

PF9024
Mitsubishi
adaptor plate assembly
(Diamante)

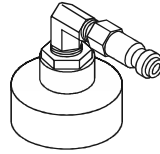

PF9025
KIA brake cap adaptor assembly

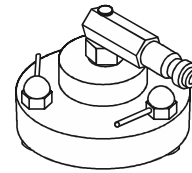

PF9027
Toyota small brake cap adaptor



G0003-220
EPDM O-ring #220

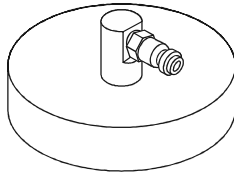

PF9028
Hino Cabover brake cap adaptor

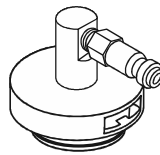

PF9033
Isuzu Cabover adaptor (pipe thread)

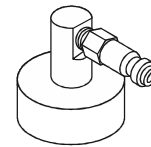

PF9035
Mazda 3/Chevy Aveo brake cap
adaptor assembly

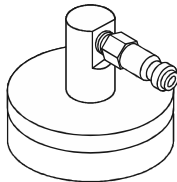

PF9036
Suzuki 2-tab
brake cap adaptor

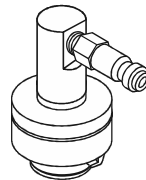

PF9037
Isuzu brake cap adaptor



G0003-013
EPDM O-ring #013



PF91002
Brake cap
adaptor seal, 1.9"